

# AOI

CATALOGO LAME

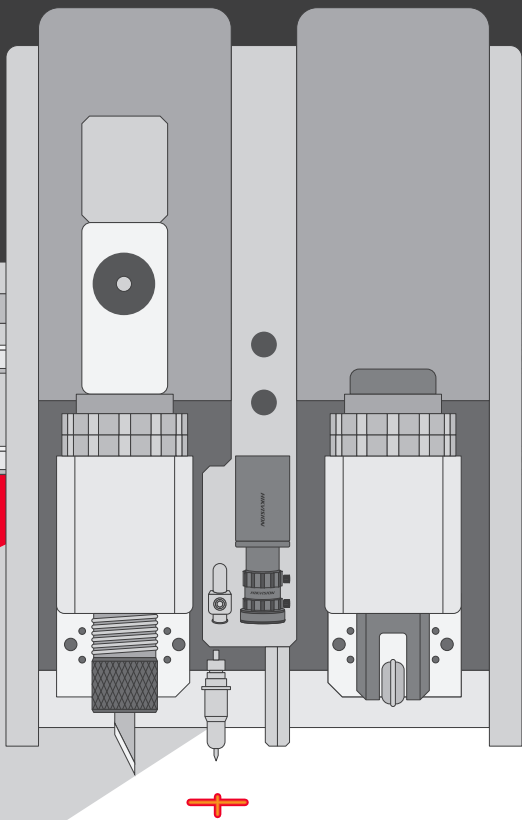

**cabelpiu'**  
CUT-MILL Specialist

# LEGENDA



KISS CUT



OSCILLANTE  
elettrico



OSCILLANTE  
pneumatico

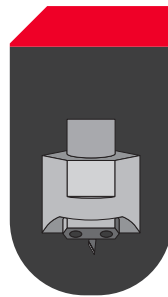

V-CUT

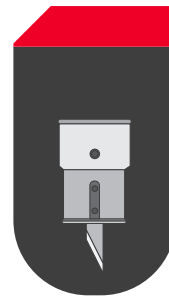

DRAG KNIFE



CORDONATORE  
TRACCIATORE

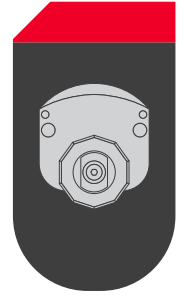

DRT

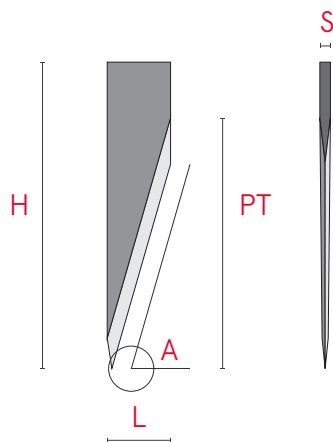

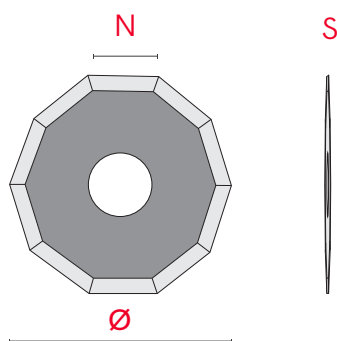

**H** Altezza della lama  
**L** Larghezza della lama  
**PT** Profondità di taglio  
**S** Spessore della lama



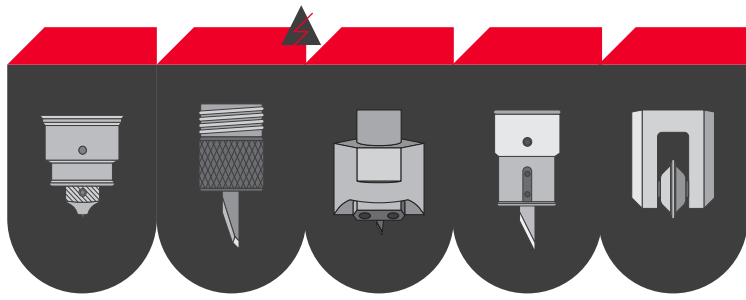

**N** Numero lati  
**S** Spessore della lama  
**Ø** Diametro della lama

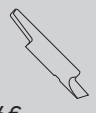

| Z026A-C                                                                           | SIZE | mm   | Utilizzo         |
|-----------------------------------------------------------------------------------|------|------|------------------|
|  | PT   | 11   | cartone ondulato |
|                                                                                   | L    | 5.5  |                  |
|                                                                                   | H    | 30   |                  |
|                                                                                   | S    | 0.63 |                  |
|                                                                                   | A    | 26°  |                  |
| 14€                                                                               |      |      |                  |

| Z126B                                                                             | SIZE | mm  | Utilizzo          |
|-----------------------------------------------------------------------------------|------|-----|-------------------|
|  | PT   | 9   | spugna            |
|                                                                                   | L    | 5.6 | acetato           |
|                                                                                   | H    | 25  | fibra di carbonio |
|                                                                                   | S    | 1   | polietilene       |
|                                                                                   | A    | 26° |                   |
| 18€                                                                               |      |     |                   |

| B001                                                                                | SIZE | mm   | Utilizzo |
|-------------------------------------------------------------------------------------|------|------|----------|
|  | PT   | 1    |          |
|                                                                                     | ψ    | 3x18 |          |
| 56€                                                                                 |      |      |          |

| Z026A-D                                                                           | SIZE | mm   | Utilizzo         |
|-----------------------------------------------------------------------------------|------|------|------------------|
|  | PT   | 11   | cartone ondulato |
|                                                                                   | L    | 5.5  |                  |
|                                                                                   | H    | 25   |                  |
|                                                                                   | S    | 0.63 |                  |
|                                                                                   | A    | 26°  |                  |
| 14€                                                                               |      |      |                  |

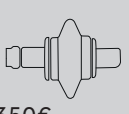
| 20*R1                                                                             | SIZE | mm | Utilizzo         |
|-----------------------------------------------------------------------------------|------|----|------------------|
|  | LLP  | 2  | cartone ondulato |
|                                                                                   |      |    |                  |
| 350€                                                                              |      |    |                  |

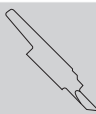
| B002                                                                                | SIZE | mm   | Utilizzo |
|-------------------------------------------------------------------------------------|------|------|----------|
|  | PT   | 2    |          |
|                                                                                     | ψ    | 3x18 |          |
| 56€                                                                                 |      |      |          |

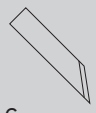
| Z035A                                                                              | SIZE | mm   | Utilizzo       |
|------------------------------------------------------------------------------------|------|------|----------------|
|  | PT   | 8.5  | carta/cartone  |
|                                                                                    | L    | 5.5  | spugna         |
|                                                                                    | H    | 30   | guarnizioni    |
|                                                                                    | S    | 0.63 | tessuto, pelle |
|                                                                                    | A    | 35°  | forex          |
| 14€                                                                                |      |      |                |

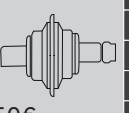
| 20*R0.5                                                                            | SIZE | mm | Utilizzo        |
|------------------------------------------------------------------------------------|------|----|-----------------|
|  | LLP  | 1  | cartoncino teso |
|                                                                                    |      |    |                 |
| 350€                                                                               |      |    |                 |

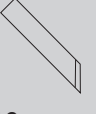
| Z045A-C                                                                             | SIZE | mm   | Utilizzo         |
|-------------------------------------------------------------------------------------|------|------|------------------|
|  | PT   | 5    | cartone ondulato |
|                                                                                     | L    | 5.5  |                  |
|                                                                                     | H    | 30   |                  |
|                                                                                     | S    | 0.63 |                  |
|                                                                                     | A    | 45°  |                  |
| 14€                                                                                 |      |      |                  |

| 10127205                                                                            | SIZE | mm   | Utilizzo |
|-------------------------------------------------------------------------------------|------|------|----------|
|  | PT   | 1.2  | cartone  |
|                                                                                     | ψ    | 20x1 |          |
|                                                                                     |      | /    |          |
|                                                                                     |      | /    |          |
| 25€                                                                                 |      |      |          |

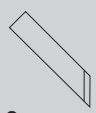
| Z045A                                                                               | SIZE | mm   | Utilizzo       |
|-------------------------------------------------------------------------------------|------|------|----------------|
|  | PT   | 6    | carta/cartone  |
|                                                                                     | L    | 5.5  | spugna         |
|                                                                                     | H    | 30   | guarnizioni    |
|                                                                                     | S    | 0.63 | tessuto, pelle |
|                                                                                     | A    | 45°  | forex          |
| 14€                                                                                 |      |      |                |

| 1020206026                                                                          | SIZE | mm   | Utilizzo |
|-------------------------------------------------------------------------------------|------|------|----------|
|  | PT   | 1.5  | cartone  |
|                                                                                     | ψ    | 20x1 |          |
| 75€                                                                                 |      |      |          |

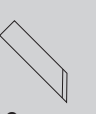
| Z045A-D                                                                             | SIZE | mm   | Utilizzo         |
|-------------------------------------------------------------------------------------|------|------|------------------|
|  | PT   | 5    | cartone ondulato |
|                                                                                     | L    | 5.5  |                  |
|                                                                                     | H    | 25   |                  |
|                                                                                     | S    | 0.63 |                  |
|                                                                                     | A    | 45°  |                  |
| 14€                                                                                 |      |      |                  |

| V501AH                                                                              | SIZE | mm   | Utilizzo         |
|-------------------------------------------------------------------------------------|------|------|------------------|
|  | PT   | 5/45 | Cartone ondulato |
|                                                                                     | L    | 5.5  |                  |
|                                                                                     | H    | 22.5 |                  |
|                                                                                     | S    | 1    |                  |
|                                                                                     | A    | /    |                  |
| 18€                                                                                 |      |      |                  |

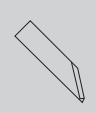
| Z026B                                                                               | SIZE | mm   | Utilizzo          |
|-------------------------------------------------------------------------------------|------|------|-------------------|
|  | PT   | 9    | spugna            |
|                                                                                     | L    | 5.6  | acetato           |
|                                                                                     | H    | 25   | fibra di carbonio |
|                                                                                     | S    | 0.63 | polietilene       |
|                                                                                     | A    | 26°  |                   |
| 14€                                                                                 |      |      |                   |

| V501BH                                                                              | SIZE | mm   | Utilizzo         |
|-------------------------------------------------------------------------------------|------|------|------------------|
|  | PT   | 5    | Cartone ondulato |
|                                                                                     | L    | 5.5  |                  |
|                                                                                     | H    | 22.5 |                  |
|                                                                                     | S    | 1    |                  |
|                                                                                     | A    | 45°  |                  |
| 18€                                                                                 |      |      |                  |

\*LLP: Larghezza Linea Pressione

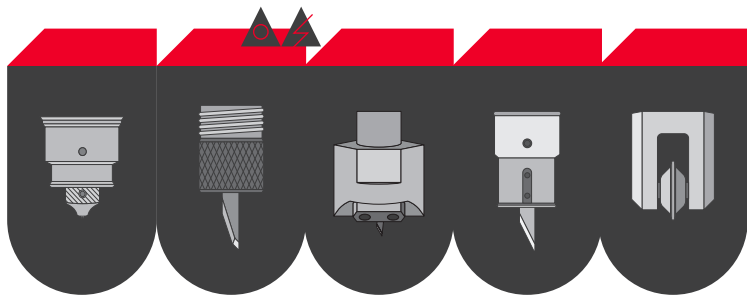

| Z016A                                                                             | SIZE | mm   | Utilizzo       |
|-----------------------------------------------------------------------------------|------|------|----------------|
|  | PT   | 20   | carta/cartone  |
|                                                                                   | L    | 6    | spugna         |
|                                                                                   | H    | 29   | guarnizioni    |
|                                                                                   | S    | 0.63 | tessuto, pelle |
|                                                                                   | A    | 16°  | forex          |

14€

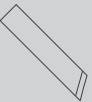
| Z060A                                                                             | SIZE | mm   | Utilizzo       |
|-----------------------------------------------------------------------------------|------|------|----------------|
|  | PT   | 3.5  | carta/cartone  |
|                                                                                   | L    | 6    | spugna         |
|                                                                                   | H    | 30   | guarnizioni    |
|                                                                                   | S    | 0.63 | tessuto, pelle |
|                                                                                   | A    | 60°  | forex          |

14€

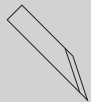
| Z026A-C                                                                             | SIZE | mm   | Utilizzo         |
|-------------------------------------------------------------------------------------|------|------|------------------|
|  | PT   | 11   | cartone ondulato |
|                                                                                     | L    | 5.5  |                  |
|                                                                                     | H    | 30   |                  |
|                                                                                     | S    | 0.63 |                  |
|                                                                                     | A    | 26°  |                  |

14€

| Z025A                                                                             | SIZE | mm   | Utilizzo       |
|-----------------------------------------------------------------------------------|------|------|----------------|
|  | PT   | 13   | carta/cartone  |
|                                                                                   | L    | 6    | spugna         |
|                                                                                   | H    | 29   | guarnizioni    |
|                                                                                   | S    | 0.63 | tessuto, pelle |
|                                                                                   | A    | 25°  | forex          |

14€

| Z116A                                                                             | SIZE | mm   | Utilizzo       |
|-----------------------------------------------------------------------------------|------|------|----------------|
|  | PT   | 20.9 | carta/cartone  |
|                                                                                   | L    | 6    | spugna         |
|                                                                                   | H    | 30   | guarnizioni    |
|                                                                                   | S    | 0.1  | tessuto, pelle |
|                                                                                   | A    | 16°  | forex          |

18€

| Z026A-D                                                                             | SIZE | mm   | Utilizzo         |
|-------------------------------------------------------------------------------------|------|------|------------------|
|  | PT   | 11   | cartone ondulato |
|                                                                                     | L    | 5.5  |                  |
|                                                                                     | H    | 25   |                  |
|                                                                                     | S    | 0.63 |                  |
|                                                                                     | A    | 26°  |                  |

14€

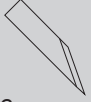
| Z026A                                                                              | SIZE | mm   | Utilizzo       |
|------------------------------------------------------------------------------------|------|------|----------------|
|  | PT   | 12   | carta/cartone  |
|                                                                                    | L    | 6    | spugna         |
|                                                                                    | H    | 30   | guarnizioni    |
|                                                                                    | S    | 0.63 | tessuto, pelle |
|                                                                                    | A    | 26°  | forex          |

14€

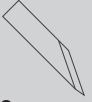
| Z126A                                                                              | SIZE | mm  | Utilizzo       |
|------------------------------------------------------------------------------------|------|-----|----------------|
|  | PT   | 12  | carta/cartone  |
|                                                                                    | L    | 6   | spugna         |
|                                                                                    | H    | 30  | guarnizioni    |
|                                                                                    | S    | 1   | tessuto, pelle |
|                                                                                    | A    | 26° | forex          |

18€

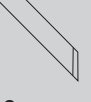
| Z045A-C                                                                              | SIZE | mm   | Utilizzo         |
|--------------------------------------------------------------------------------------|------|------|------------------|
|  | PT   | 5    | cartone ondulato |
|                                                                                      | L    | 5.5  |                  |
|                                                                                      | H    | 30   |                  |
|                                                                                      | S    | 0.63 |                  |
|                                                                                      | A    | 45°  |                  |

14€

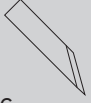
| Z030A                                                                               | SIZE | mm   | Utilizzo       |
|-------------------------------------------------------------------------------------|------|------|----------------|
|  | PT   | 10   | carta/cartone  |
|                                                                                     | L    | 6    | spugna         |
|                                                                                     | H    | 30   | guarnizioni    |
|                                                                                     | S    | 0.63 | tessuto, pelle |
|                                                                                     | A    | 30°  | forex          |

14€

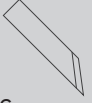
| Z135A                                                                               | SIZE | mm  | Utilizzo       |
|-------------------------------------------------------------------------------------|------|-----|----------------|
|  | PT   | 8   | carta/cartone  |
|                                                                                     | L    | 6   | spugna         |
|                                                                                     | H    | 30  | guarnizioni    |
|                                                                                     | S    | 1   | tessuto, pelle |
|                                                                                     | A    | 35° | forex          |

18€

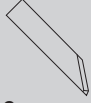
| Z035B                                                                                 | SIZE | mm   | Utilizzo          |
|---------------------------------------------------------------------------------------|------|------|-------------------|
|  | PT   | 9    | spugna            |
|                                                                                       | L    | 6    | acetato           |
|                                                                                       | H    | 30   | fibra di carbonio |
|                                                                                       | S    | 0.63 | polietilene       |
|                                                                                       | A    | 35°  |                   |

14€

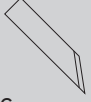
| Z035A                                                                               | SIZE | mm   | Utilizzo       |
|-------------------------------------------------------------------------------------|------|------|----------------|
|  | PT   | 8.5  | carta/cartone  |
|                                                                                     | L    | 6    | spugna         |
|                                                                                     | H    | 30   | guarnizioni    |
|                                                                                     | S    | 0.63 | tessuto, pelle |
|                                                                                     | A    | 35°  | forex          |

14€

| Z145A                                                                               | SIZE | mm  | Utilizzo       |
|-------------------------------------------------------------------------------------|------|-----|----------------|
|  | PT   | 6   | carta/cartone  |
|                                                                                     | L    | 6   | spugna         |
|                                                                                     | H    | 30  | guarnizioni    |
|                                                                                     | S    | 1   | tessuto, pelle |
|                                                                                     | A    | 45° | forex          |

18€

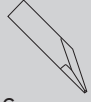
| ZS026B                                                                                | SIZE | mm   | Utilizzo          |
|---------------------------------------------------------------------------------------|------|------|-------------------|
|  | PT   | 10   | spugna            |
|                                                                                       | L    | 6    | acetato           |
|                                                                                       | H    | 29   | fibra di carbonio |
|                                                                                       | S    | 0.63 | polietilene       |
|                                                                                       | A    | 10°  |                   |

21€

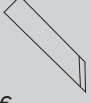
| Z039A                                                                               | SIZE | mm   | Utilizzo       |
|-------------------------------------------------------------------------------------|------|------|----------------|
|  | PT   | 6    | carta/cartone  |
|                                                                                     | L    | 6    | spugna         |
|                                                                                     | H    | 30   | guarnizioni    |
|                                                                                     | S    | 0.63 | tessuto, pelle |
|                                                                                     | A    | 39°  | forex          |

14€

| Z145B                                                                               | SIZE | mm  | Utilizzo       |
|-------------------------------------------------------------------------------------|------|-----|----------------|
|  | PT   | 6   | carta/cartone  |
|                                                                                     | L    | 6   | spugna         |
|                                                                                     | H    | 30  | guarnizioni    |
|                                                                                     | S    | 1   | tessuto, pelle |
|                                                                                     | A    | 45° | forex          |

18€

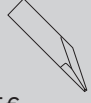
| ZS126B                                                                                | SIZE | mm  | Utilizzo          |
|---------------------------------------------------------------------------------------|------|-----|-------------------|
|  | PT   | 12  | spugna            |
|                                                                                       | L    | 6   | acetato           |
|                                                                                       | H    | 29  | fibra di carbonio |
|                                                                                       | S    | 1   | polietilene       |
|                                                                                       | A    | 10° |                   |

25€

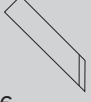
| Z045A                                                                               | SIZE | mm   | Utilizzo       |
|-------------------------------------------------------------------------------------|------|------|----------------|
|  | PT   | 6    | carta/cartone  |
|                                                                                     | L    | 6    | spugna         |
|                                                                                     | H    | 30   | guarnizioni    |
|                                                                                     | S    | 0.63 | tessuto, pelle |
|                                                                                     | A    | 45°  | forex          |

14€

| Z045A-D                                                                             | SIZE | mm   | Utilizzo         |
|-------------------------------------------------------------------------------------|------|------|------------------|
|  | PT   | 5    | cartone ondulato |
|                                                                                     | L    | 5.5  |                  |
|                                                                                     | H    | 25   |                  |
|                                                                                     | S    | 0.63 |                  |
|                                                                                     | A    | 45°  |                  |

14€

| Z030C                                                                                 | SIZE | mm  | Utilizzo          |
|---------------------------------------------------------------------------------------|------|-----|-------------------|
|  | PT   | 8   | spugna            |
|                                                                                       | L    | 6   | acetato           |
|                                                                                       | H    | 30  | fibra di carbonio |
|                                                                                       | S    | 1   | polietilene       |
|                                                                                       | A    | 30° |                   |

28€

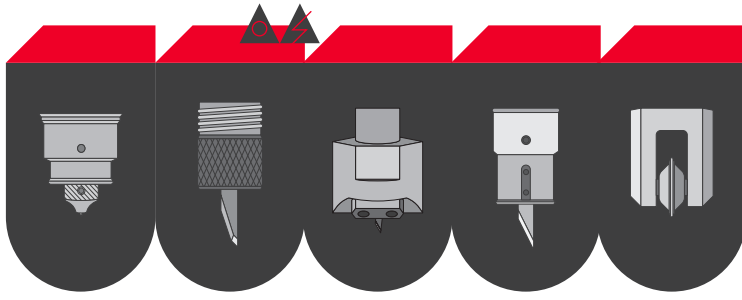



# 1070 PLUS/BIG

| 30774                                                                             | SIZE | mm   | Utilizzo |
|-----------------------------------------------------------------------------------|------|------|----------|
|  | PT   | 13-6 | Pelle    |
|                                                                                   | L    | 6.3  |          |
|                                                                                   | H    | 28   |          |
|                                                                                   | S    | 0.63 |          |
|                                                                                   | A    | /    |          |
| 42€                                                                               |      |      |          |

| 30774-1                                                                           | SIZE | mm   | Utilizzo |
|-----------------------------------------------------------------------------------|------|------|----------|
|  | PT   | 13-6 | Pelle    |
|                                                                                   | L    | 6.3  |          |
|                                                                                   | H    | 28   |          |
|                                                                                   | S    | 0.63 |          |
|                                                                                   | A    | /    |          |
| 42€                                                                               |      |      |          |

| 39999                                                                              | SIZE | mm  | Utilizzo |
|------------------------------------------------------------------------------------|------|-----|----------|
|  | PT   | 9   | Pelle    |
|                                                                                    | L    | 6.5 |          |
|                                                                                    | H    | 28  |          |
|                                                                                    | S    | 1   |          |
|                                                                                    | A    | /   |          |
| 42€                                                                                |      |     |          |

| C3112                                                                               | SIZE | mm | Utilizzo |
|-------------------------------------------------------------------------------------|------|----|----------|
|  | PT   | 12 | Pelle    |
|                                                                                     | L    | 7  |          |
|                                                                                     | H    | 31 |          |
|                                                                                     | S    | 1  |          |
|                                                                                     | A    | /  |          |
| 42€                                                                                 |      |    |          |

| C3512                                                                               | SIZE | mm | Utilizzo |
|-------------------------------------------------------------------------------------|------|----|----------|
|  | PT   | 15 | Pelle    |
|                                                                                     | L    | 6  |          |
|                                                                                     | H    | 35 |          |
|                                                                                     | S    | 1  |          |
|                                                                                     | A    | /  |          |
| 42€                                                                                 |      |    |          |

| 4012A                                                                               | SIZE | mm   | Utilizzo |
|-------------------------------------------------------------------------------------|------|------|----------|
|  | PT   | 18   | Pelle    |
|                                                                                     | L    | 5.8  |          |
|                                                                                     | H    | 40.3 |          |
|                                                                                     | S    | 1    |          |
|                                                                                     | A    | /    |          |
| 42€                                                                                 |      |      |          |

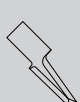
| 1003-1                                                                              | SIZE | mm | Utilizzo |
|-------------------------------------------------------------------------------------|------|----|----------|
|  | PT   | 15 | Pelle    |
|                                                                                     | L    | 8  |          |
|                                                                                     | H    | 25 |          |
|                                                                                     | S    | 1  |          |
|                                                                                     | A    | /  |          |
| 25€                                                                                 |      |    |          |

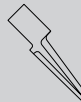
| 1003-2                                                                            | SIZE | mm  | Utilizzo |
|-----------------------------------------------------------------------------------|------|-----|----------|
|  | PT   | 19  | Pelle    |
|                                                                                   | L    | 8.5 |          |
|                                                                                   | H    | 30  |          |
|                                                                                   | S    | 1   |          |
|                                                                                   | A    | /   |          |
| 25€                                                                               |      |     |          |

| C124B                                                                             | SIZE | mm | Utilizzo |
|-----------------------------------------------------------------------------------|------|----|----------|
|  | PT   | 24 | Pelle    |
|                                                                                   | L    | 4  |          |
|                                                                                   | H    | 40 |          |
|                                                                                   | S    | 1  |          |
|                                                                                   | A    | /  |          |
| 42€                                                                               |      |    |          |

| T033                                                                               | SIZE | mm   | Utilizzo |
|------------------------------------------------------------------------------------|------|------|----------|
|  | PT   | 14   | Pelle    |
|                                                                                    | L    | 9    | Spugna   |
|                                                                                    | H    | 33   | Tessuto  |
|                                                                                    | S    | 0.63 | Schiume  |
|                                                                                    | A    | /    | Gomme    |
| 28€                                                                                |      |      |          |

| T038                                                                                | SIZE | mm   | Utilizzo |
|-------------------------------------------------------------------------------------|------|------|----------|
|  | PT   | 18   | Pelle    |
|                                                                                     | L    | 6.3  | Spugna   |
|                                                                                     | H    | 38   | Tessuto  |
|                                                                                     | S    | 0.63 | Schiume  |
|                                                                                     | A    | /    | Gomme    |
| 28€                                                                                 |      |      |          |

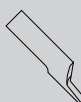
| T131                                                                                | SIZE | mm  | Utilizzo |
|-------------------------------------------------------------------------------------|------|-----|----------|
|  | PT   | 9   | Pelle    |
|                                                                                     | L    | 6.5 | Spugna   |
|                                                                                     | H    | 31  | Tessuto  |
|                                                                                     | S    | 1   | Schiume  |
|                                                                                     | A    | /   | Gomme    |
| 42€                                                                                 |      |     |          |

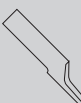
| T133                                                                                | SIZE | mm   | Utilizzo |
|-------------------------------------------------------------------------------------|------|------|----------|
|  | PT   | 11   | Pelle    |
|                                                                                     | L    | 6.2  | Spugna   |
|                                                                                     | H    | 33.5 | Tessuto  |
|                                                                                     | S    | 1    | Schiume  |
|                                                                                     | A    | /    | Gomme    |
| 42€                                                                                 |      |      |          |

| T138                                                                                | SIZE | mm  | Utilizzo |
|-------------------------------------------------------------------------------------|------|-----|----------|
|  | PT   | 17  | Pelle    |
|                                                                                     | L    | 6.5 | Spugna   |
|                                                                                     | H    | 38  | Tessuto  |
|                                                                                     | S    | 1   | Schiume  |
|                                                                                     | A    | /   | Gomme    |
| 42€                                                                                 |      |     |          |

| T142                                                                                | SIZE | mm | Utilizzo |
|-------------------------------------------------------------------------------------|------|----|----------|
|  | PT   | 22 | Pelle    |
|                                                                                     | L    | 6  | Spugna   |
|                                                                                     | H    | 42 | Tessuto  |
|                                                                                     | S    | 1  | Schiume  |
|                                                                                     | A    | /  | Gomme    |
| 42€                                                                                 |      |    |          |

| T142-1                                                                              | SIZE | mm   | Utilizzo |
|-------------------------------------------------------------------------------------|------|------|----------|
|  | PT   | 20   | Pelle    |
|                                                                                     | L    | 6.5  | Spugna   |
|                                                                                     | H    | 42   | Tessuto  |
|                                                                                     | S    | 0.63 | Schiume  |
|                                                                                     | A    | /    | Gomme    |
| 35€                                                                                 |      |      |          |

| T145(H)                                                                              | SIZE | mm    | Utilizzo |
|--------------------------------------------------------------------------------------|------|-------|----------|
|  | PT   | 34-33 | Pelle    |
|                                                                                      | L    | 6     | Spugna   |
|                                                                                      | H    | 45    | Tessuto  |
|                                                                                      | S    | 1     | Schiume  |
|                                                                                      | A    | /     | Gomme    |
| 42€                                                                                  |      |       |          |

| T1.525                                                                                | SIZE | mm  | Utilizzo |
|---------------------------------------------------------------------------------------|------|-----|----------|
|  | PT   | 5   | Pelle    |
|                                                                                       | L    | 8   | Spugna   |
|                                                                                       | H    | 25  | Tessuto  |
|                                                                                       | S    | 1,5 | Schiume  |
|                                                                                       | A    | /   | Gomme    |
| 42€                                                                                   |      |     |          |

| J319                                                                                  | SIZE | mm | Utilizzo |
|---------------------------------------------------------------------------------------|------|----|----------|
|  | PT   | 7  | Pelle    |
|                                                                                       | L    | 7  | Spugna   |
|                                                                                       | H    | 25 | Tessuto  |
|                                                                                       | S    | 1  | Schiume  |
|                                                                                       | A    | /  | Gomme    |
| 14€                                                                                   |      |    |          |

| J338                                                                                  | SIZE | mm   | Utilizzo |
|---------------------------------------------------------------------------------------|------|------|----------|
|  | PT   | 7    | Pelle    |
|                                                                                       | L    | 7    | Spugna   |
|                                                                                       | H    | 25   | Tessuto  |
|                                                                                       | S    | 0,63 | Schiume  |
|                                                                                       | A    | /    | Gomme    |
| 18€                                                                                   |      |      |          |

| J341                                                                                  | SIZE | mm   | Utilizzo |
|---------------------------------------------------------------------------------------|------|------|----------|
|  | PT   | 20,5 | Pelle    |
|                                                                                       | L    | 6    | Spugna   |
|                                                                                       | H    | 25   | Tessuto  |
|                                                                                       | S    | 0,63 | Schiume  |
|                                                                                       | A    | /    | Gomme    |
| 14€                                                                                   |      |      |          |



| C029B            |    | SIZE | mm |
|------------------|----|------|----|
|                  | PT | 18   |    |
|                  | L  | 6    |    |
|                  | H  | 29   |    |
|                  | S  | 0.63 |    |
|                  | A  | /    |    |
| <b>Utilizzo</b>  |    |      |    |
| Cartone ondulato |    |      |    |
| Spugna           |    |      |    |
| Tessuto          |    |      |    |
| 14€              |    |      |    |

| C140B            |    | SIZE | mm |
|------------------|----|------|----|
|                  | PT | 24   |    |
|                  | L  | 6    |    |
|                  | H  | 40   |    |
|                  | S  | 1    |    |
|                  | A  | /    |    |
| <b>Utilizzo</b>  |    |      |    |
| Cartone ondulato |    |      |    |
| Spugna           |    |      |    |
| Tessuto          |    |      |    |
| 27€              |    |      |    |

| ZP140B           |    | SIZE | mm |
|------------------|----|------|----|
|                  | PT | 24   |    |
|                  | L  | 6    |    |
|                  | H  | 40   |    |
|                  | S  | 1    |    |
|                  | A  | /    |    |
| <b>Utilizzo</b>  |    |      |    |
| Cartone ondulato |    |      |    |
| Spugna           |    |      |    |
| Tessuto          |    |      |    |
| 27€              |    |      |    |

| C150B-2          |    | SIZE | mm |
|------------------|----|------|----|
|                  | PT | 38   |    |
|                  | L  | 6    |    |
|                  | H  | 50   |    |
|                  | S  | 2    |    |
|                  | A  | /    |    |
| <b>Utilizzo</b>  |    |      |    |
| Cartone ondulato |    |      |    |
| Spugna           |    |      |    |
| Tessuto          |    |      |    |
| 39€              |    |      |    |

| C040B            |    | SIZE | mm |
|------------------|----|------|----|
|                  | PT | 24   |    |
|                  | L  | 6    |    |
|                  | H  | 40   |    |
|                  | S  | 0.63 |    |
|                  | A  | /    |    |
| <b>Utilizzo</b>  |    |      |    |
| Cartone ondulato |    |      |    |
| Spugna           |    |      |    |
| Tessuto          |    |      |    |
| 27€              |    |      |    |

| ZP040B           |    | SIZE | mm |
|------------------|----|------|----|
|                  | PT | 24   |    |
|                  | L  | 6    |    |
|                  | H  | 40   |    |
|                  | S  | 0.63 |    |
|                  | A  | /    |    |
| <b>Utilizzo</b>  |    |      |    |
| Cartone ondulato |    |      |    |
| Spugna           |    |      |    |
| Tessuto          |    |      |    |
| 27€              |    |      |    |

| C150B-1          |    | SIZE | mm |
|------------------|----|------|----|
|                  | PT | 37   |    |
|                  | L  | 6    |    |
|                  | H  | 50   |    |
|                  | S  | 1    |    |
|                  | A  | /    |    |
| <b>Utilizzo</b>  |    |      |    |
| Cartone ondulato |    |      |    |
| Spugna           |    |      |    |
| Tessuto          |    |      |    |
| 36€              |    |      |    |

| C165B            |    | SIZE | mm |
|------------------|----|------|----|
|                  | PT | 50   |    |
|                  | L  | 6    |    |
|                  | H  | 65   |    |
|                  | S  | 1    |    |
|                  | A  | /    |    |
| <b>Utilizzo</b>  |    |      |    |
| Cartone ondulato |    |      |    |
| Spugna           |    |      |    |
| Tessuto          |    |      |    |
| 39€              |    |      |    |

| C175B            |    | SIZE | mm |
|------------------|----|------|----|
|                  | PT | 65   |    |
|                  | L  | 6    |    |
|                  | H  | 75   |    |
|                  | S  | 1    |    |
|                  | A  | /    |    |
| <b>Utilizzo</b>  |    |      |    |
| Cartone ondulato |    |      |    |
| Spugna           |    |      |    |
| Tessuto          |    |      |    |
| 39€              |    |      |    |

| C182B            |    | SIZE | mm |
|------------------|----|------|----|
|                  | PT | 70   |    |
|                  | L  | 6    |    |
|                  | H  | 82   |    |
|                  | S  | 1    |    |
|                  | A  | /    |    |
| <b>Utilizzo</b>  |    |      |    |
| Cartone ondulato |    |      |    |
| Spugna           |    |      |    |
| Tessuto          |    |      |    |
| 62€              |    |      |    |

| JCT52            |    | SIZE | mm |
|------------------|----|------|----|
|                  | PT | 38   |    |
|                  | L  | 6    |    |
|                  | H  | 52   |    |
|                  | S  | 1,5  |    |
|                  | A  | /    |    |
| <b>Utilizzo</b>  |    |      |    |
| Cartone ondulato |    |      |    |
| Spugna           |    |      |    |
| Tessuto          |    |      |    |
| 84€              |    |      |    |

| JCT82            |    | SIZE | mm |
|------------------|----|------|----|
|                  | PT | 62   |    |
|                  | L  | 6    |    |
|                  | H  | 82   |    |
|                  | S  | 1,5  |    |
|                  | A  | /    |    |
| <b>Utilizzo</b>  |    |      |    |
| Cartone ondulato |    |      |    |
| Spugna           |    |      |    |
| Tessuto          |    |      |    |
| 77€              |    |      |    |





| JC50                                                                              |    | SIZE | mm |
|-----------------------------------------------------------------------------------|----|------|----|
|  | PT | 40   |    |
|                                                                                   | L  | 6    |    |
|                                                                                   | H  | 50   |    |
|                                                                                   | S  | 1    |    |
|                                                                                   | A  | /    |    |
| <b>Utilizzo</b>                                                                   |    |      |    |
| Cartone ondulato                                                                  |    |      |    |
| Spugna                                                                            |    |      |    |
| Tessuto                                                                           |    |      |    |
| 98€                                                                               |    |      |    |

| JCT65                                                                             |    | SIZE | mm |
|-----------------------------------------------------------------------------------|----|------|----|
|  | PT | 54   |    |
|                                                                                   | L  | 6    |    |
|                                                                                   | H  | 65   |    |
|                                                                                   | S  | 1    |    |
|                                                                                   | A  | /    |    |
| <b>Utilizzo</b>                                                                   |    |      |    |
| Cartone ondulato                                                                  |    |      |    |
| Spugna                                                                            |    |      |    |
| Tessuto                                                                           |    |      |    |
| 98€                                                                               |    |      |    |

| JCT97                                                                             |    | SIZE | mm |
|-----------------------------------------------------------------------------------|----|------|----|
|  | PT | 77   |    |
|                                                                                   | L  | 6    |    |
|                                                                                   | H  | 97   |    |
|                                                                                   | S  | 1,5  |    |
|                                                                                   | A  | /    |    |
| <b>Utilizzo</b>                                                                   |    |      |    |
| Cartone ondulato                                                                  |    |      |    |
| Spugna                                                                            |    |      |    |
| Tessuto                                                                           |    |      |    |
| 84€                                                                               |    |      |    |

| T162-2                                                                              |    | SIZE  | mm |
|-------------------------------------------------------------------------------------|----|-------|----|
|  | PT | 50/48 |    |
|                                                                                     | L  | 6     |    |
|                                                                                     | H  | 62    |    |
|                                                                                     | S  | 1     |    |
|                                                                                     | A  | /     |    |
| <b>Utilizzo</b>                                                                     |    |       |    |
| Cartone ondulato                                                                    |    |       |    |
| Spugna                                                                              |    |       |    |
| Tessuto                                                                             |    |       |    |
| 49€                                                                                 |    |       |    |

| T165(H)                                                                             |    | SIZE  | mm |
|-------------------------------------------------------------------------------------|----|-------|----|
|  | PT | 54/52 |    |
|                                                                                     | L  | 6     |    |
|                                                                                     | H  | 64    |    |
|                                                                                     | S  | 1     |    |
|                                                                                     | A  | /     |    |
| <b>Utilizzo</b>                                                                     |    |       |    |
| Cartone ondulato                                                                    |    |       |    |
| Spugna                                                                              |    |       |    |
| Tessuto                                                                             |    |       |    |
| 49€                                                                                 |    |       |    |

| T182                                                                                |    | SIZE | mm |
|-------------------------------------------------------------------------------------|----|------|----|
|  | PT | 66   |    |
|                                                                                     | L  | 6    |    |
|                                                                                     | H  | 82   |    |
|                                                                                     | S  | 1    |    |
|                                                                                     | A  | /    |    |
| <b>Utilizzo</b>                                                                     |    |      |    |
| Cartone ondulato                                                                    |    |      |    |
| Spugna                                                                              |    |      |    |
| Tessuto                                                                             |    |      |    |
| 49€                                                                                 |    |      |    |

| T1.582                                                                              |    | SIZE | mm |
|-------------------------------------------------------------------------------------|----|------|----|
|  | PT | 63   |    |
|                                                                                     | L  | 6    |    |
|                                                                                     | H  | 82,5 |    |
|                                                                                     | S  | 1,5  |    |
|                                                                                     | A  | /    |    |
| <b>Utilizzo</b>                                                                     |    |      |    |
| Cartone ondulato                                                                    |    |      |    |
| Spugna                                                                              |    |      |    |
| Tessuto                                                                             |    |      |    |
| 77€                                                                                 |    |      |    |

| T163                                                                                  |    | SIZE | mm |
|---------------------------------------------------------------------------------------|----|------|----|
|  | PT | 53   |    |
|                                                                                       | L  | 6    |    |
|                                                                                       | H  | 63,5 |    |
|                                                                                       | S  | 1    |    |
|                                                                                       | A  | /    |    |
| <b>Utilizzo</b>                                                                       |    |      |    |
| Cartone ondulato                                                                      |    |      |    |
| Spugna                                                                                |    |      |    |
| Tessuto                                                                               |    |      |    |
| 49€                                                                                   |    |      |    |

| T175                                                                                |    | SIZE | mm |
|-------------------------------------------------------------------------------------|----|------|----|
|  | PT | 54/6 |    |
|                                                                                     | L  | 5,5  |    |
|                                                                                     | H  | 75   |    |
|                                                                                     | S  | 1    |    |
|                                                                                     | A  | 6    |    |
| <b>Utilizzo</b>                                                                     |    |      |    |
| Cartone ondulato                                                                    |    |      |    |
| Spugna                                                                              |    |      |    |
| Tessuto                                                                             |    |      |    |
| 49€                                                                                 |    |      |    |

| T187                                                                                |    | SIZE | mm |
|-------------------------------------------------------------------------------------|----|------|----|
|  | PT | 72   |    |
|                                                                                     | L  | 6    |    |
|                                                                                     | H  | 87   |    |
|                                                                                     | S  | 1    |    |
|                                                                                     | A  | /    |    |
| <b>Utilizzo</b>                                                                     |    |      |    |
| Cartone ondulato                                                                    |    |      |    |
| Spugna                                                                              |    |      |    |
| Tessuto                                                                             |    |      |    |
| 53€                                                                                 |    |      |    |

| T1.595                                                                              |    | SIZE | mm |
|-------------------------------------------------------------------------------------|----|------|----|
|  | PT | 83   |    |
|                                                                                     | L  | 6    |    |
|                                                                                     | H  | 95   |    |
|                                                                                     | S  | 1,5  |    |
|                                                                                     | A  | /    |    |
| <b>Utilizzo</b>                                                                     |    |      |    |
| Cartone ondulato                                                                    |    |      |    |
| Spugna                                                                              |    |      |    |
| Tessuto                                                                             |    |      |    |
| 84€                                                                                 |    |      |    |

| T275(H)                                                                               |    | SIZE | mm |
|---------------------------------------------------------------------------------------|----|------|----|
|  | PT | 58   |    |
|                                                                                       | L  | 6    |    |
|                                                                                       | H  | 75   |    |
|                                                                                       | S  | 2    |    |
|                                                                                       | A  | /    |    |
| <b>Utilizzo</b>                                                                       |    |      |    |
| Pelle                                                                                 |    |      |    |
| Spugna                                                                                |    |      |    |
| Tessuto                                                                               |    |      |    |
| Schiume                                                                               |    |      |    |
| Gomme                                                                                 |    |      |    |
| 67€                                                                                   |    |      |    |

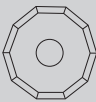

| Y025A                                                                             | SIZE | mm   | Utilizzo          |
|-----------------------------------------------------------------------------------|------|------|-------------------|
|  | N    | 10   | Tessuto           |
|                                                                                   | Ø    | 25   | Fibra di carbonio |
|                                                                                   | S    | 0.63 | Moquette          |
|                                                                                   |      |      | Tappeti           |
| 42€                                                                               |      |      |                   |

| Y025B                                                                             | SIZE | mm   | Utilizzo          |
|-----------------------------------------------------------------------------------|------|------|-------------------|
|  | N    | /    | Tessuto           |
|                                                                                   | Ø    | 25   | Fibra di carbonio |
|                                                                                   | S    | 0.63 | Moquette          |
|                                                                                   |      |      | Tappeti           |
| 35€                                                                               |      |      |                   |

| Y028A                                                                              | SIZE | mm   | Utilizzo          |
|------------------------------------------------------------------------------------|------|------|-------------------|
|  | N    | 10   | Tessuto           |
|                                                                                    | Ø    | 28   | Fibra di carbonio |
|                                                                                    | S    | 0.63 | Moquette          |
|                                                                                    |      |      | Tappeti           |
| 46€                                                                                |      |      |                   |

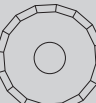
| Y028A-1                                                                             | SIZE | mm   | Utilizzo          |
|-------------------------------------------------------------------------------------|------|------|-------------------|
|  | N    | 16   | Tessuto           |
|                                                                                     | Ø    | 28   | Fibra di carbonio |
|                                                                                     | S    | 0.63 | Moquette          |
|                                                                                     |      |      | Tappeti           |
| 56€                                                                                 |      |      |                   |

| Y028B                                                                               | SIZE | mm   | Utilizzo          |
|-------------------------------------------------------------------------------------|------|------|-------------------|
|  | N    | /    | Tessuto           |
|                                                                                     | Ø    | 28   | Fibra di carbonio |
|                                                                                     | S    | 0.63 | Moquette          |
|                                                                                     |      |      | Tappeti           |
| 39€                                                                                 |      |      |                   |

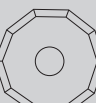
| Y030A                                                                               | SIZE | mm   | Utilizzo          |
|-------------------------------------------------------------------------------------|------|------|-------------------|
|  | N    | 10   | Tessuto           |
|                                                                                     | Ø    | 30   | Fibra di carbonio |
|                                                                                     | S    | 0.63 | Moquette          |
|                                                                                     |      |      | Tappeti           |
| 46€                                                                                 |      |      |                   |

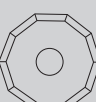
| Y032A                                                                               | SIZE | mm   | Utilizzo          |
|-------------------------------------------------------------------------------------|------|------|-------------------|
|  | N    | 10   | Tessuto           |
|                                                                                     | Ø    | 32   | Fibra di carbonio |
|                                                                                     | S    | 0.63 | Moquette          |
|                                                                                     |      |      | Tappeti           |
| 46€                                                                                 |      |      |                   |

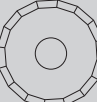
| Y032A-1                                                                           | SIZE | mm   | Utilizzo          |
|-----------------------------------------------------------------------------------|------|------|-------------------|
|  | N    | 16   | Tessuto           |
|                                                                                   | Ø    | 32   | Fibra di carbonio |
|                                                                                   | S    | 0.63 | Moquette          |
|                                                                                   |      |      | Tappeti           |
| 46€                                                                               |      |      |                   |

| Y034A                                                                             | SIZE | mm   | Utilizzo          |
|-----------------------------------------------------------------------------------|------|------|-------------------|
|  | N    | 10   | Tessuto           |
|                                                                                   | Ø    | 34   | Fibra di carbonio |
|                                                                                   | S    | 0.63 | Moquette          |
|                                                                                   |      |      | Tappeti           |
| 53€                                                                               |      |      |                   |

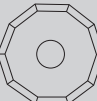
| Y036A                                                                              | SIZE | mm   | Utilizzo          |
|------------------------------------------------------------------------------------|------|------|-------------------|
|  | N    | 10   | Tessuto           |
|                                                                                    | Ø    | 36   | Fibra di carbonio |
|                                                                                    | S    | 0.63 | Moquette          |
|                                                                                    |      |      | Tappeti           |
| 53€                                                                                |      |      |                   |

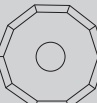
| Y040A                                                                               | SIZE | mm   | Utilizzo          |
|-------------------------------------------------------------------------------------|------|------|-------------------|
|  | N    | 10   | Tessuto           |
|                                                                                     | Ø    | 40   | Fibra di carbonio |
|                                                                                     | S    | 0.63 | Moquette          |
|                                                                                     |      |      | Tappeti           |
| 53€                                                                                 |      |      |                   |

| Y044C                                                                               | SIZE | mm   | Utilizzo          |
|-------------------------------------------------------------------------------------|------|------|-------------------|
|  | N    | 20   | Tessuto           |
|                                                                                     | Ø    | 44   | Fibra di carbonio |
|                                                                                     | S    | 0.63 | Moquette          |
|                                                                                     |      |      | Tappeti           |
| 84€                                                                                 |      |      |                   |

| Y045B                                                                               | SIZE | mm   | Utilizzo          |
|-------------------------------------------------------------------------------------|------|------|-------------------|
|  | N    | /    | Tessuto           |
|                                                                                     | Ø    | 45   | Fibra di carbonio |
|                                                                                     | S    | 0.63 | Moquette          |
|                                                                                     |      |      | Tappeti           |
| 56€                                                                                 |      |      |                   |

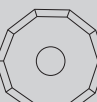
| Y050A                                                                               | SIZE | mm   | Utilizzo          |
|-------------------------------------------------------------------------------------|------|------|-------------------|
|  | N    | 10   | Tessuto           |
|                                                                                     | Ø    | 50   | Fibra di carbonio |
|                                                                                     | S    | 0.63 | Moquette          |
|                                                                                     |      |      | Tappeti           |
| 70€                                                                                 |      |      |                   |

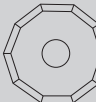
| Y044A                                                                               | SIZE | mm   | Utilizzo          |
|-------------------------------------------------------------------------------------|------|------|-------------------|
|  | N    | 10   | Tessuto           |
|                                                                                     | Ø    | 44   | Fibra di carbonio |
|                                                                                     | S    | 0.63 | Moquette          |
|                                                                                     |      |      | Tappeti           |
| 53€                                                                                 |      |      |                   |

| JCYL248                                                                             | SIZE | mm  | Utilizzo |
|-------------------------------------------------------------------------------------|------|-----|----------|
|  | PT   | 5   | cartone  |
|                                                                                     | L    | 8   |          |
|                                                                                     | H    | 25  |          |
|                                                                                     | S    | 1.5 |          |
|                                                                                     | A    | /   |          |
| 70€                                                                                 |      |     |          |

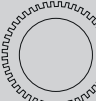
| JCYL242                                                                              | SIZE | mm | Utilizzo |
|--------------------------------------------------------------------------------------|------|----|----------|
|  | PT   | 7  | cartone  |
|                                                                                      | L    | 6  |          |
|                                                                                      | H    | 25 |          |
|                                                                                      | S    | 1  |          |
|                                                                                      | A    | 7° |          |
| 70€                                                                                  |      |    |          |

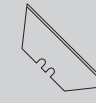
| XQ01                                                                                  | SIZE | mm   | Utilizzo         |
|---------------------------------------------------------------------------------------|------|------|------------------|
|  | PT   | 19   | Cartone ondulato |
|                                                                                       | L    | 19   |                  |
|                                                                                       | H    | 61   |                  |
|                                                                                       | S    | 0.63 |                  |
|                                                                                       | A    | /    |                  |
| 30€                                                                                   |      |      |                  |

| XQT01    | SIZE | mm   | Utilizzo         |
|----------|------|------|------------------|
| Ceramica | PT   | 19   | Cartone ondulato |
|          | L    | 19   |                  |
|          | H    | 61   |                  |
|          | S    | 0.63 |                  |
|          | A    | /    |                  |
| 28€      |      |      |                  |

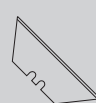
| XQW02                                                                                 | SIZE | mm | Utilizzo         |
|---------------------------------------------------------------------------------------|------|----|------------------|
|  | PT   | 19 | Cartone ondulato |
|                                                                                       | L    | 19 |                  |
|                                                                                       | H    | 61 |                  |
|                                                                                       | S    | 1  |                  |
|                                                                                       | A    | /  |                  |
| 63€                                                                                   |      |    |                  |

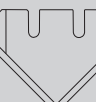
| E74                                                                                   | SIZE | mm | Utilizzo         |
|---------------------------------------------------------------------------------------|------|----|------------------|
|  | PT   | 30 | Cartone ondulato |
|                                                                                       | L    | 52 |                  |
|                                                                                       | H    | 46 |                  |
|                                                                                       | S    | 1  |                  |
|                                                                                       | A    | /  |                  |
| 63€                                                                                   |      |    |                  |





| T1.597                                                                            | SIZE            | mm   |
|-----------------------------------------------------------------------------------|-----------------|------|
|  | PT              | 77   |
|                                                                                   | L               | 6    |
|                                                                                   | H               | 97.5 |
|                                                                                   | S               | 1.5  |
|                                                                                   | A               | /    |
|                                                                                   | <b>Utilizzo</b> |      |
| Cartone ondulato                                                                  |                 |      |
| Spugna                                                                            |                 |      |
| Tessuto                                                                           |                 |      |
|                                                                                   |                 |      |
|                                                                                   |                 |      |
|                                                                                   |                 |      |
|                                                                                   |                 |      |
|                                                                                   |                 |      |
|                                                                                   |                 |      |
| 91€                                                                               |                 |      |

| T1.5115                                                                             | SIZE            | mm  |
|-------------------------------------------------------------------------------------|-----------------|-----|
|  | PT              | 103 |
|                                                                                     | L               | 6   |
|                                                                                     | H               | 115 |
|                                                                                     | S               | 1.5 |
|                                                                                     | A               | /   |
|                                                                                     | <b>Utilizzo</b> |     |
| Cartone ondulato                                                                    |                 |     |
| Spugna                                                                              |                 |     |
| Tessuto                                                                             |                 |     |
|                                                                                     |                 |     |
|                                                                                     |                 |     |
|                                                                                     |                 |     |
|                                                                                     |                 |     |
|                                                                                     |                 |     |
|                                                                                     |                 |     |
| 98€                                                                                 |                 |     |

| Z46                                                                                 | SIZE            | mm  |
|-------------------------------------------------------------------------------------|-----------------|-----|
|  | PT              | 20  |
|                                                                                     | L               | 6   |
|                                                                                     | H               | 50  |
|                                                                                     | S               | 1.5 |
|                                                                                     | A               | /   |
|                                                                                     | <b>Utilizzo</b> |     |
| Cartone ondulato                                                                    |                 |     |
| Spugna                                                                              |                 |     |
| Tessuto                                                                             |                 |     |
|                                                                                     |                 |     |
|                                                                                     |                 |     |
|                                                                                     |                 |     |
|                                                                                     |                 |     |
|                                                                                     |                 |     |
|                                                                                     |                 |     |
| 42€                                                                                 |                 |     |

Numero cliente:

|  |  |  |  |  |  |  |  |
|--|--|--|--|--|--|--|--|
|  |  |  |  |  |  |  |  |
|--|--|--|--|--|--|--|--|

**Cabel+ SRL**  
Via Marconi, 2  
20068 Peschiera Borromeo,  
(MI)  
Italia

info@cabelpiu.it  
+39 0255300792

\_\_\_\_\_

Ditta

\_\_\_\_\_

Contatto

\_\_\_\_\_

Via/ numero civico

\_\_\_\_\_

CAP/ città/ provincia

\_\_\_\_\_

Telefono

\_\_\_\_\_

email

\_\_\_\_\_

P.IVA

## Modulo d'ordine

| Quantità | Codice articolo | Prezzo |
|----------|-----------------|--------|
| _____    | _____           | _____  |
| _____    | _____           | _____  |
| _____    | _____           | _____  |
| _____    | _____           | _____  |
| _____    | _____           | _____  |
| _____    | _____           | _____  |
| _____    | _____           | _____  |
| _____    | _____           | _____  |
| _____    | _____           | _____  |
| _____    | _____           | _____  |

Totale: \_\_\_\_\_

Ordine minimo 100,-€. Spese di spedizione capoluoghi Italia: 11,00€;  
Calabria e Sicilia: 18,00€; Sardegna: 20,00€  
Costi per spedizioni speciali: su richiesta  
Pagamento: bonifico bancario anticipato

### Dettagli Banche:

Banco di Desio e della Brianza spa:  
Filiale Via Giovanni Battista Cassinis, 15,  
20100-Milano  
IBAN: IT 18 J 03440 01611 000000228600  
BIC BDBDIT22

\_\_\_\_\_

Data

\_\_\_\_\_

Firma

Tutti i prezzi contenuti nel catalogo sono da intendersi senza IVA- Sede Legale: Via  
Marconi, 2-Peschiera Borromeo-Milano- Amministratore Unico: Fabio Pelizzoli  
Responsabile Amministrativa: Monica Burlini- Partita IVA: IT03795710965

Banco BPM:

Filiale di Peschiera Borromeo  
IBAN: IT 17 U 05034 33570 000000001153

